



# JVC

## TU-HD500A





HD DIGITAL TERRESTRIAL SET TOP BOX INSTRUCTIONS



**DVB**  
Digital Video  
Broadcasting



# Safety Information

	<b>CAUTION</b> RISK OF ELECTRIC SHOCK DO NOT OPEN	
<b>CAUTION:</b> TO REDUCE THE RISK OF ELECTRIC SHOCK, DO NOT OPEN. NO USER-SERVICEABLE PARTS INSIDE. REFER SERVICING TO QUALIFIED SERVICE PERSONNEL ONLY.		



The lightning flash with arrowhead symbol within an equilateral triangle, is intended to alert the user to the presence of uninsulated "dangerous voltage" within the product's enclosure that may be of sufficient magnitude to constitute a risk of electric shock.



The exclamation point within an equilateral triangle is intended to alert the user to the presence of important operating and servicing instructions in the literature accompanying the appliance.

**WARNING:** TO REDUCE THE RISK OF FIRE OR ELECTRIC SHOCK, DO NOT EXPOSE THIS APPLIANCE TO RAIN OR MOISTURE.

**CAUTION:** TO PREVENT ELECTRIC SHOCK, MATCH AC WALL MOUNTED SOCKET AND PRODUCT'S PLUG, FULLY INSERT.

**CAUTION:** CHANGE OR MODIFICATIONS NOT EXPRESSLY APPROVED BY THE MANUFACTURER COULD VOID THE USER'S AUTHORITY TO OPERATE THE EQUIPMENT.

**CAUTION:** TO PREVENT PERMANENT DAMAGE OF FLAT PANEL DISPLAY (PDP TV, PDP MONITOR, etc.), WHEN CHANNEL INFORMATION DISPLAY WITH "Radio Broadcast" OR "Loss of Signal" LONG TIME, PLEASE TURN OFF THE TV SET.

# Important Safeguard

This sheet lists important safeguard that will help to assure your enjoyment and proper use of the HD-STB and accessory. Please read them carefully before operating and using your HD-STB product.

## 1. Read and Retain these User's Guide

All the safety and User's Guide should be read before the HD-STB is operated. Follow all User's Guide. The safety and User's Guide should be retained for future reference. Comply with all warnings on the HD-STB and in the User's Guide.

## 2. Use Correct Power

This HD-STB should be operated only from the type of power source indicated on the rear panel. If you are not sure of the type of power supply to your home, please consult your HD-STB dealer or local electric company.

## 3. Install to Stable Place

Do not place this HD-STB an unstable cart, stand, tripod, bracket, or table. The HD-STB may fall, causing serious injury to a child or adult as well as serious damage to the HD-STB. Use this HD-STB product only with a cart, stand, tripod, bracket, or table recommended by the manufacturer or sold with the HD-STB product. Any mounting of the product should followed the manufacturer's instruction and use a mounting accessory to recommended by the manufacturer. HD-STB and cart combination should be moved with care. Quick stops, excessive force, and uneven surfaces may cause the HD-STB and cart combination to overturn.

## 4. Provide Antenna Ground

If an outside antenna or cable system is connected to the HD-STB, be sure the antenna or cable system is grounded so as to provide some protection against voltage surges and built-up static charges. An outside antenna system should not be located in the vicinity of overhead power lines, other electric light or power circuits, or where it can fall into such power lines or circuits. When installing an outside antenna system, extreme care should be taken to keep from touching or approaching such power lines or circuits as contact with them might be fatal. Installing an outdoor antenna can be hazardous and should be left to a professional antenna installer.

## 5. Provide Proper Ventilation

Slot and openings in the cabinet are provided for ventilation to ensure reliable operation of the HD-STB and to protect it from overheating. These openings must not be blocked or covered. This HD-STB should not be placed in a built-in installation such as a bookcase or rack unless proper ventilation is provided. For sufficient ventilation, there must be at least 10cm free air space above, behind and on each side of the HD-STB.

## 6. Keep Away from Heat

Do not expose the HD-STB under the direct sunlight. The product should be situated away from heat sources such as radiators, heat registers, stoves, or other product (including amplifiers) that produce heat.

## 7. Keep Away from Moisture

Do not use this HD-STB near water or wet place. For example, near a bathtub, wash bowl, kitchen sink, laundry tub, in a wet basement, or near a swimming pool and the like.

Caution: Maintain electrical safety, Power line operated equipment or accessories connected to this unit should bear the CE listing mark or C-Tick certification mark on the accessory itself and should not be modified so as to defeat the safety features. This will help avoid any potential hazard from electrical shock or fire. If the power is in doubt contact qualified service personnel.

## 8. Do Not Open

Do not attempt to service this HD-STB yourself, as opening or removing cabinet may expose you to dangerous voltage. To prevent of the risk of fire or electric shock, do not open the cabinet. There are no user serviceable parts inside the HD-STB. Refer servicing to qualified service personnel only.

## 9. Unplug before Cleaning

For the cleaning of the HD-STB, turn the HD-STB power off and unplug from the wall AC outlet before cleaning. Do not use liquid cleaners or aerosol cleaners. Use a damp cloth for cleaning.

## 10. Object and Liquid Entry

Never push objects of any kind into this HD-STB through openings as they may touch dangerous voltage points or short-out parts that could result in a fire or electric shock.

Never spill liquid of any kind on the HD-STB.

## 11. For Additional Protection

For added protection for this HD-STB during a lightning storm, or when it is left unattended and unused for long periods of time, unplug it from the AC wall outlet and disconnect the antenna or cable system. This will prevent damage to the HD-STB due to lightning and power line surges.

# CONTENTS

<b>1. Overview of the equipment</b>	<b>3</b>
Front Panel	3
Rear Panel	4
Remote Controller	5
TV CONTROL SECTION	6
Installing the remote control batteries	7
Using the remote control	7
Accessories	8
<b>2. Connecting your HD-STB</b>	<b>9</b>
<b>1) Antenna Connection</b>	<b>9</b>
Connecting an antenna with HD-STB, TV and VCR	9
Connecting an antenna with HD-STB and TV	9
<b>2) Video Connection</b>	<b>10</b>
Connecting to a HDTV with HD YPbPr	10
Connecting to a HDTV with HD VGA	10
Connecting to a SDTV with SD YPbPr	11
Connecting to a SDTV with SD RGB	11
Connecting to a Conventional TV with S-Video	12
Connecting to a Conventional TV with Composite Video	12
<b>3) Audio Connection</b>	<b>13</b>
Stereo Audio Connection	13
Digital Audio Connection	13
<b>4) Setting up the Display Mode</b>	<b>14</b>
<b>3. Getting Started</b>	<b>15</b>
Step 1. Check up the contents in the Carton box.	15
Step 2. Connect ANT Cable.	15
Step 3. Connecting the Video and Video Mode Setting.	15
Step 4. Connecting the Audio.	15
Step 5. Connecting the Power.	15
Step 6. Install Remote Control battery and TV Control Section Code Setting	16
Step 7. Check up the On Screen Display.	16
Step 8. Automatic Channel Search and Channel Change.	16
<b>4. INFO button and EPG Information Display</b>	<b>17</b>
<b>1) EPG Information Display</b>	<b>17</b>
<b>2) Channel Information Display</b>	<b>18</b>
<b>3) CH LIST Display</b>	<b>18</b>
<b>5. Using menu system</b>	<b>19</b>
<b>1) Audio/ Video Setting</b>	<b>19</b>
TV Display	20
Screen H Position	20
Screen V Position	20
Audio Preference	20

# Contents

Audio Downmix	21
MPEG Audio Adj.	21
Sub Title	21
<b>2) Time Setting</b>	<b>22</b>
Clock Setting	22
Time Zone	23
Wake Up Timer	23
Off Timer	24
Sleep Timer	24
<b>3) System Setup</b>	<b>25</b>
Power Restore	25
Auto Power Off	25
Menu Time Out	25
OSD Transparency	25
Display Dimmer	26
TV Remote Cnt'l Code List	26
Factory Reset	26
Software Version	26
<b>4) Parental Guide</b>	<b>27</b>
Block All Rating/ Unblock All Rating	27
Rating Setup	28
Change PIN Number	28
<b>5) Channel Setup</b>	<b>29</b>
Automatic CH Tuning	29
Manual CH Search	29
Favorite CH	30
<b>Edit Program</b>	<b>31</b>
Edit Program · Edit	31
Edit Program · Move	32
Edit Program · Delete	33
Program Preference	34
Aerial Signal Strength	35
<b>6. Troubleshooting</b>	<b>36</b>
<b>7. Specifications</b>	<b>37</b>
<b>8. Universal Code Setting for remote control</b>	<b>39</b>

# Overview of the equipment

This section summarizes the buttons, controls, and terminals that you will use with your HD-STB.

## Front Panel

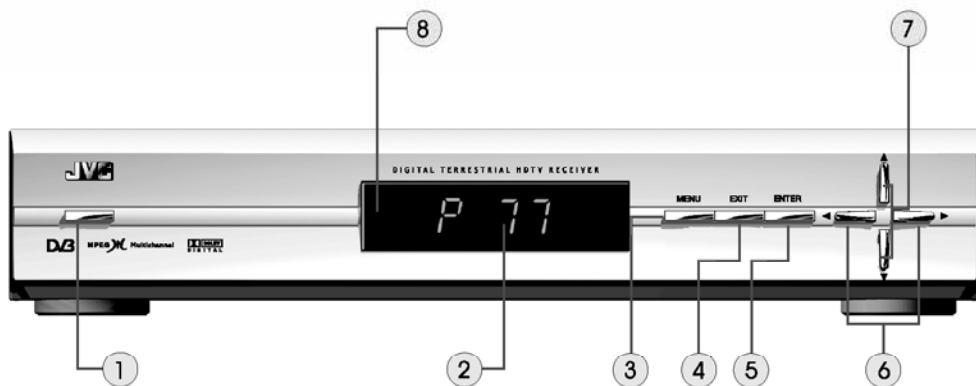

- 1. POWER**  
Press to turn the HD-STB on or off.
- 2. Display Panel**  
Display information to assist you in operating the HD-STB successfully.
- 3. MENU**  
Activate the menu system.
- 4. EXIT**  
Quit the menu system
- 5. ENTER**  
Select the items in the menu system.
- 6. PROGRAM Up/ Down**  
"Press to change the program (This action changes the programs stored in the favorite channels memory blocks)."  
"Left or Right movement in the menu system."
- 7. CHANNEL Up/ Down**  
"Press to change the channels (This action changes the memorized channels in sequence)."  
"Up or Down movement in the menu system."
- 8. Remote Sensor**  
This HD-STB receives infrared remote signal from your remote control. Do not block it.



## Rear Panel

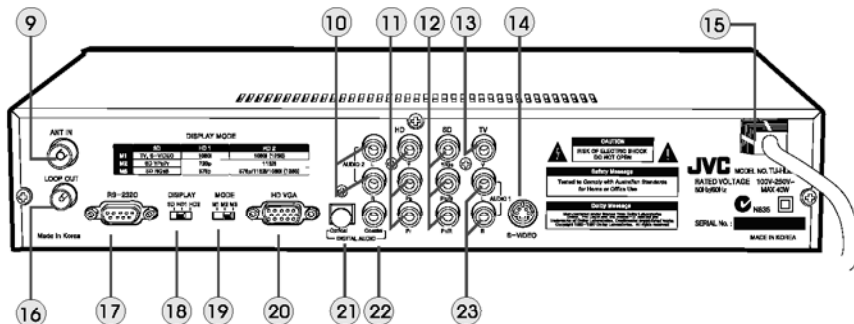

### 9. ANT IN terminal

Attach an external Antenna to this terminal

### 10. AUDIO 2 Output terminal(L/R Analog Stereo)

This terminal can be used with your TV analog audio input. Refer to Audio Connection Pages.

### 11. HD YPbPr (HD Component Video) Output terminal

Use this terminal with your TV HD Component Video input. (HDTV Only)

### 12. SD YPbPr or SD RGB (SD Component Video) Output terminal

Use this terminal with your TV equipped with Component Video input (SD or Normal TV) For designated output type, please refer to DISPLAY MODE table.

### 13. TV Composite Video Output terminal (CVBS)

Use this terminal with your TV Video input.

### 14. S-Video Output terminal

Use this terminal with your TV S-Video input.

### 15. Power Cord

Plug this Cord to the specified AC Power socket.

### 16. LOOP OUT terminal

Use this terminal to feed RF signal to your TV or VCR for analog reception.

### 17. RS-232C

For service use only.

### 18. DISPLAY select switch

Set this switch in conjunction with MODE switch according to your TV display capability.

### 19. MODE select switch

Set this switch in conjunction with DISPLAY switch according to your TV display capability.

### 20. HD VGA (HD Component RGBHV) Output terminal

Use this terminal with your TV HD VGA Video input. (Only HDTV equipped with VGA input or Computer Monitor)

### 21. Optical Digital Audio (S/P DIF) Output terminal

Use this terminal with A/V device equipped with Optical Digital input for 5.1 Dolby Digital.

### 22. Coaxial Digital Audio (S/P DIF) Output terminal

Use this terminal with A/V device equipped with Coaxial Digital input for 5.1 Dolby Digital.

### 23. AUDIO 1 Output terminal (L/R Analog Stereo)

This terminal can be used with your TV analog audio input. Refer to Audio Connection pages.

# Overview of the equipment

## Remote Controller

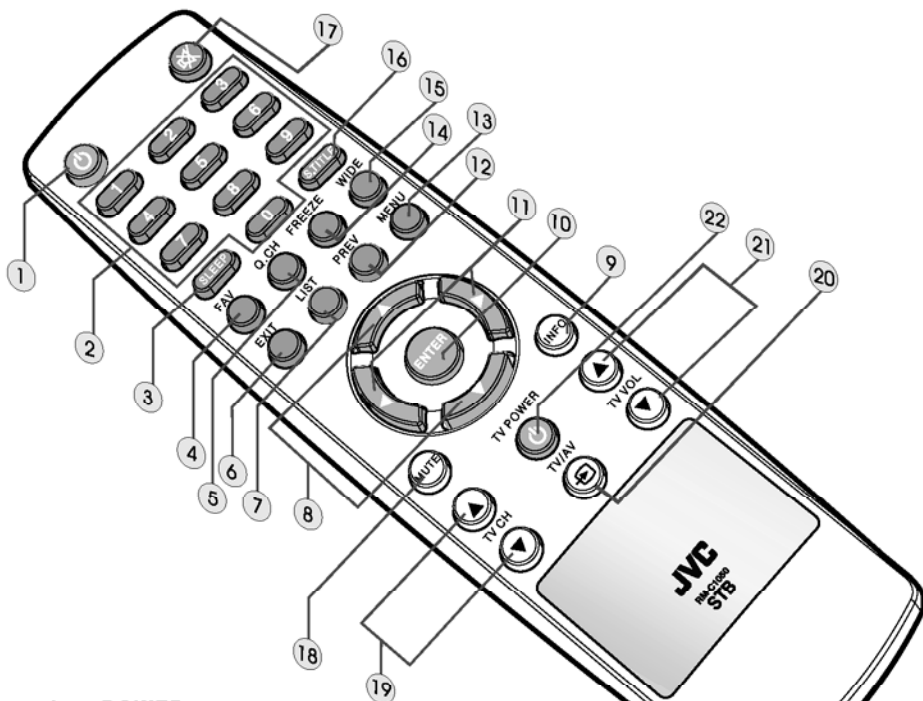

**1. POWER**

Turn your HD-STB on or off.

**2. 0~9 (Number Button)**

Direct change the desired channel.

To change the channel, simply press desired channel number.

The button operation should be less than 2 seconds between button pressing.

If it is over 2 seconds then this HD-STB will discard the pressed number and go back to current channel.

**3. SLEEP**

Press to adjustment the period of Off time. Each time you press SLEEP button, time will change Off → 15min → 30 min → 45 min → 60 min → 90 min

120 min → 180 min → 240 min → Off

If you want disable sleep timer mode, simply set up to "Off".

**4. FAV (Favorite)**

Direct change the Favorite CH in the menu.

It is activate the selected favorite memory block in the Program Preference.

Followed by press, selected favorite memory block will change below

All → Fav1 → Fav2 → Fav3 → All

**5. QUICK CH (Quick Channel)**

To quick memorized channel change.

When the CH LIST is displayed then press QUICK CH button for quick channel memory.

Then, at any time, you press QUICK CH button, then you can direct change to the memorized channel.

**6. EXIT**

Quit the menu system.

# Overview of the equipment

7. **LIST**  
Display the selected memorized channel list followed by Favorite CH select.  
You can direct select desired channel using CH ◀/▶, PR ▼/▲ button.
8. **CH ▲/▼ (UP/DOWN)**  
Change the Channel Up or Down followed by memorized channel.  
In the menu system, move up or down the cursor.
9. **INFO ( Information)**  
Display current channel EPG information. You can see the NOW and NEXT information.  
If you press INFO button again, you can see the more detailed information.  
For exit the EPG display, simply press EXIT button.
10. **ENTER**  
Select the current setting in the menu system.
11. **PR ◀/▶ (Left/ Right)**  
Change the program up or down.  
In the menu system, move left or the cursor.
12. **PREV ( Previous Channel)**  
Direct go to the previous watched channel.
13. **MENU**  
Activate the menu system.
14. **FREEZE**  
Freezing the picture for viewing with still image. Sound mute is also activated.
15. **WIDE**  
To picture aspect ratio change. It will change to 4:3PS ➔ 4:3LB ➔ 16:9 ➔ 4:3PS  
4:3 PS : 4:3 Pan and Scan  
4:3 LB : 4:3 Letter Box
16. **S TITLE (Sub Title)**  
Activate Sub Title (Caption) display On/ Off.
17. **MUTE**  
Activate audio output mute.  
If user change channels, then the mute function will automatic release.  
When mute is activated, the MUTE ON will appear on the display.  
For release the mute function, simply press MUTE button again.

## TV CONTROL SECTION

For correct TV Control Section operation, you should set up the TV Control Section code.  
Refer to the TV Control Section code Setting.

18. **MUTE (TV mute)**  
Activate TV MUTE operation.
19. **TV CH ▲/▼**  
Change the TV analog channel Up or Down.
20. **TV/AV (External Video Input Select)**  
Select the TV external video input.
21. **TV VOL ▲/▼**  
Change the TV Volume level Up or Down.
22. **TV POWER**  
Turn On/ Off the TV set.

# Overview of the equipment

## Installing the remote control batteries.

- Do not mix different types of batteries, or mix an old and a new battery.
  - Remove and replace weak batteries, Weak batteries can leak and damage your Remote controller.
  - Dispose of batteries properly, never throw them into a fire.
1. Open the battery compartment on the back of the remote control.
  2. Install two AAA/R03 size batteries as shown.  
Make sure the "+" and "-" terminals are oriented correctly.
  3. Replace the cover.
  4. After change the batteries, please reset the TV Control Section code.

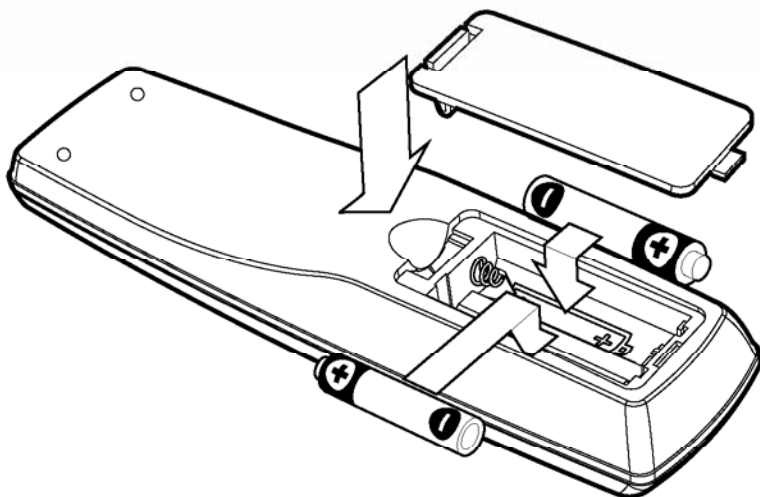

## Using the remote control.

1. Object between the remote control and HD-STB will block the path of the remote control beam.
2. Dark walls, direct sunshine or very bright light will reduce the remote sensor's sensitivity.
3. The remote control will not work correctly if you press several buttons at the same time.
4. Hold the remote control within an angle range of about 30 degree from either side of the remote sensor.  
The remote control range is about 23 feet (7 meters) from the HD-STB.

# Overview of the equipment

## Accessories.

Carefully remove the HD-STB from the carton. Check that the HD-STB has not been damaged.

The following accessories are included.

### 1. Wireless Universal RM-C1050

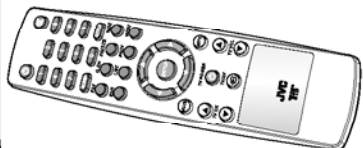

### 2. Two AAA/R03 size batteries.

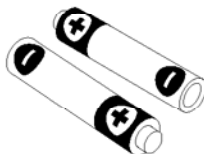

### 3. This User's Guide



### 4. A/V Cable

SD A/V Cable (Yellow/White/Red)  
HD Video Cable (Green/Blue/Red)

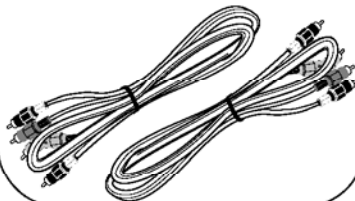

### 5. RF Cable



# Connecting your HD-STB

You should connect your HD-STB to an external antenna. Follow the direction Antenna Connection.

Next you will connect the HD-STB to the TV, HDTV or HD Monitor. Follow the direction Video Connection.

And you will connect the HD-STB to TV Audio or Home Theater Audio system. Follow the direction Audio Connection.

## 1. Antenna Connection

### Connecting an antenna with HD-STB, TV and VCR

Connect the IEC-Male antenna cable end onto the ANT IN terminal on the rear of your HD-STB.

Connect the antenna cable end between the LOOP OUT terminal on the rear of your HD-STB and ANT IN terminal on the rear of your VCR.

Connect another antenna cable end between the RF OUT terminal on the rear of your VCR and RF IN terminal on your TV. ( Refer to Fig.1 )

### Connecting an antenna with HD-STB and TV

Connect the IEC-Male antenna cable end onto the ANT IN terminal on the rear of your HD-STB.

Connect the antenna cable end between the LOOP OUT terminal on the rear of your HD-STB and RF IN terminal on your TV. ( Refer to Fig.2 )

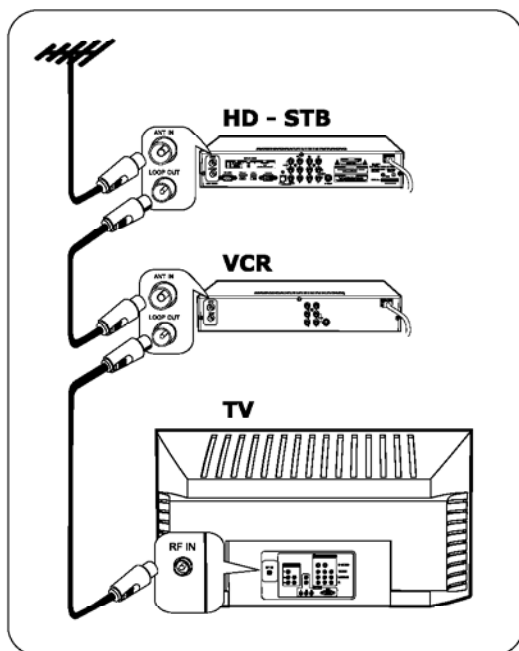

**Fig.1 HD-STB Antenna Connection with TV and VCR**

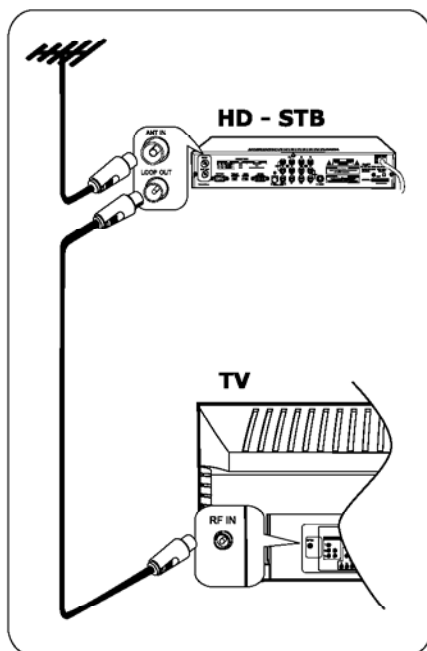

**Fig.2 HD-STB Antenna Connection with TV only**

## 2. Video Connection

### Connecting to a HDTV with HD YPbPr

Connect YPbPr Video cable to the HD terminal on the rear of HD-STB.  
Connect the other end of YPbPr Video cable to the HD YPbPr Input terminal on the HDTV.

Usually, the Y is Green, Pb is Blue and Pr is Red color assigned.  
Setting Up the Display Switch to HD 1 ( Native Mode) or HD 2 ( CRT Display) and Mode Switch to desired resolutions. (Refer to Fig.3)

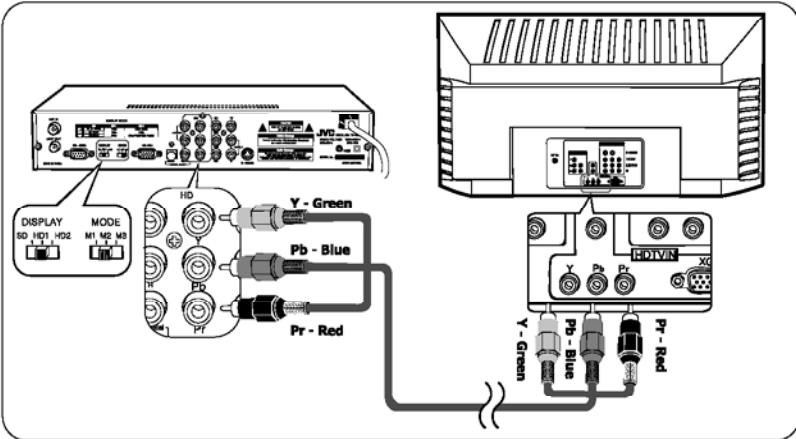
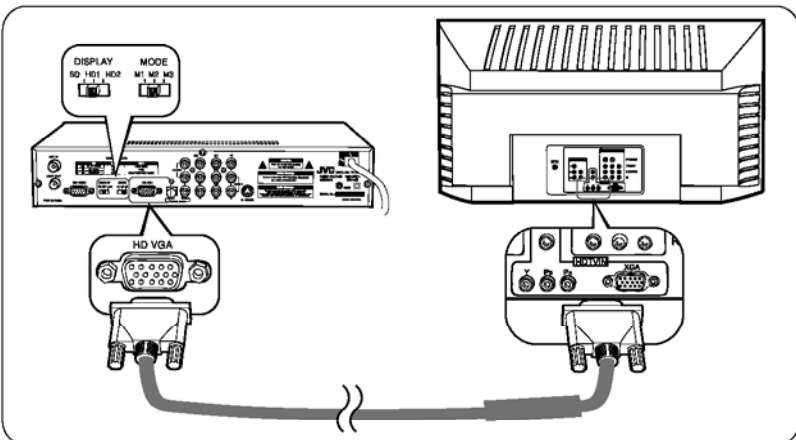

**Fig.3 HD YPbPr Video Connection**

### Connecting to a HDTV with HD VGA

Connect HD VGA Video cable to the HD VGA terminal on the rear of HD-STB.  
Connect the other end of HD VGA Video cable to the HD VGA Input terminal on the HDTV.

Setting Up the Display Switch to HD 1 ( Native Mode) or HD 2 ( CRT Display) and Mode Switch to desired resolutions. (Refer to Fig.4)

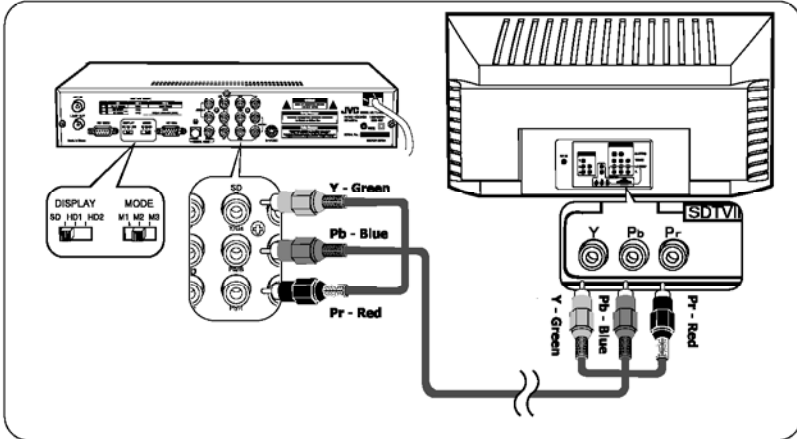

**Fig.4 HD VGA Video Connection**

# Connecting your HD-STB

## Connecting to a SDTV with SD YPbPr

Connect YPbPr Video cable to the SD terminal on the rear of HD-STB.  
Connect the other end of YPbPr Video cable to the SD YPbPr Input terminal on the TV.  
Usually, the Y is Green, Pb is Blue and Pr is Red color assigned.  
Setting Up the Display Switch to SD and Mode Switch to M2. (Refer to Fig.5)



**Fig.5 SD YPbPr Video Connection**

## Connecting to a SDTV with SD RGB

Connect RGB Video cable to the SD RGB terminal on the rear of HD-STB.  
Connect the other end of RGB Video cable to the SD RGB Input terminal on the TV.  
Setting Up the Display Switch to SD and Mode Switch to M3. (Refer to Fig.6)  
Note: This HD-STB cannot support SCART type connector, so you cannot connector SCART input TV.

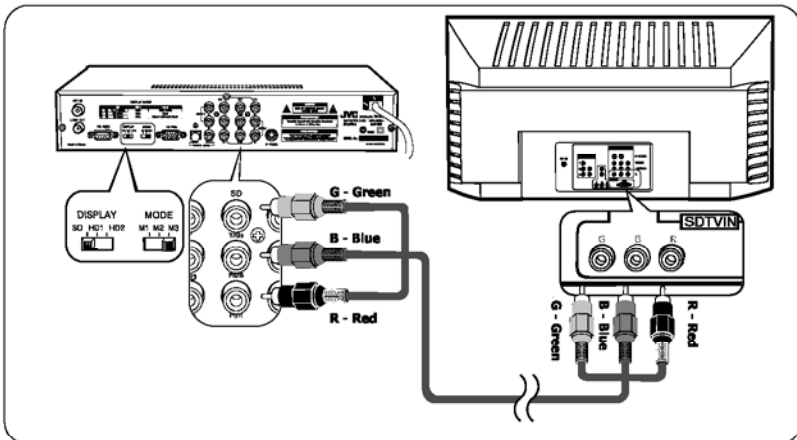

**Fig.6 SD RGB Video Connection**



# Connecting your HD-STB

## Connecting to a Conventional TV with S-Video

Connect a S-Video cable to the S-Video terminal on the rear of HD-STB. Connect the other end of S-Video cable to the S-Video input terminal on the TV. Setting up the Display Switch to SD and Mode Switch to M1. ( Refer to Fig. 7 )

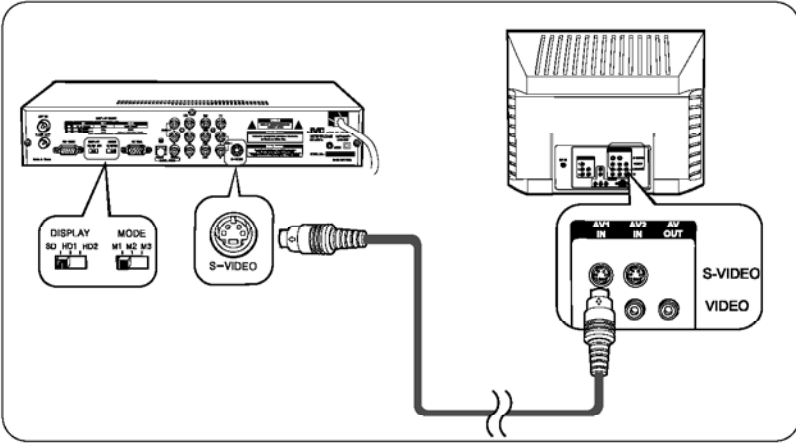

**Fig.7 TV with S-Video Connection**

## Connecting to a Conventional TV with Composite Video

Connect a Video Cable to the TV Video terminal on the rear of the HD-STB. Connect the other end of Video Cable to the Video In terminal on the TV. Setting up the Display Switch to SD and Mode Switch to M1. ( Refer to Fig. 8 )

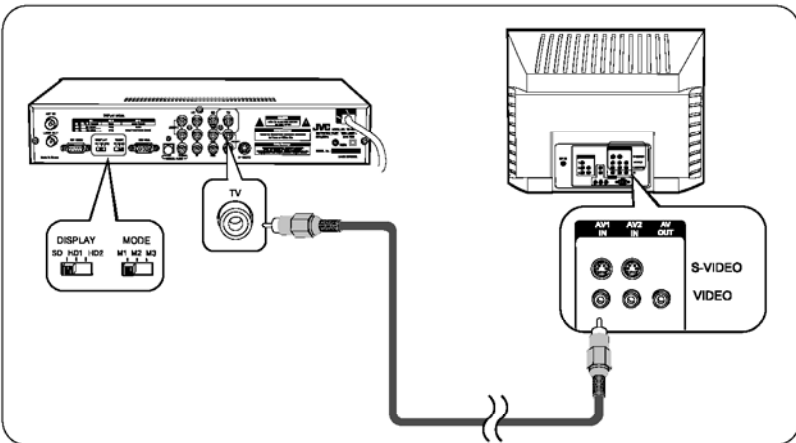

**Fig. 8 TV with Composite Video Connection**

# Connecting your HD-STB

## 3. Audio Connection

This HD-STB can support four different way of audio connection. Each of the audio connection deliver the same audio sound. You can select desired audio connection followed by below Audio Connection Diagram.

### Stereo Audio Connection

The Audio 1 and Audio 2 are deliver analog stereo sound or Dolby Digital Downmixed 2 Channel analog stereo sound.

Connect Audio Cable to the Audio 1 or Audio 2 terminal on the rear of the HD-STB. Connect the other end of the Audio Cable to the conventional TV Audio Input or Stereo Amplifier Audio Input. ( Refer to Fig. 9 )

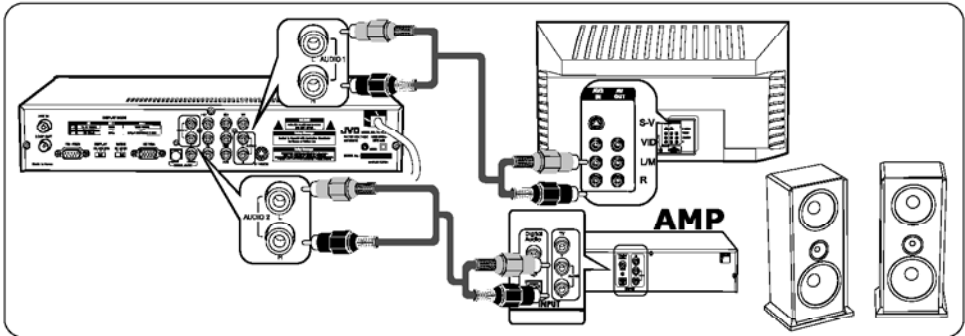

Fig.9 Stereo Audio Connection

### Digital Audio Connection

The Optical Digital Audio and Coaxial Digital Audio are deliver Dolby Digital 5.1 digital sound or PCM digital sound.

If you have Home Theater System and it can received Digital Audio, then you can connect Digital Audio.

For the Optical Digital Audio connection, Connect the Optical Digital Audio Cable ( Available in Local Store ) to the Optical Audio terminal on the rear of the HD-STB. Connect the other end of the Optical Digital Audio Cable to the Optical Audio Input terminal on the Home Theater System.

For the Coaxial Digital Audio connection, Connect the RCA Cable to the Coaxial Audio terminal on the rear of the HD-STB. Connect the other end of the RCA Cable to the Coaxial Audio Input terminal on the Home Theater System.

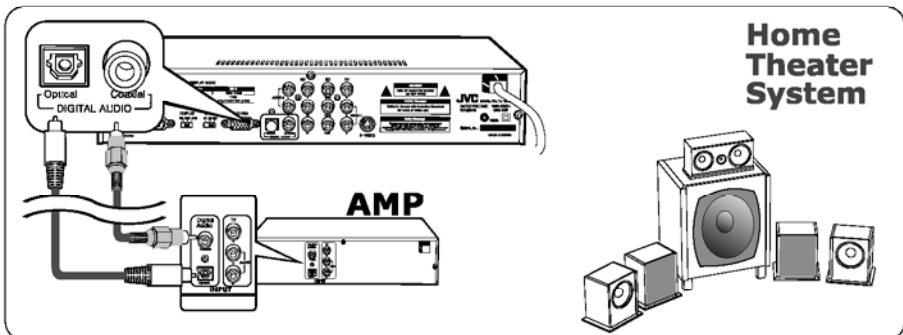

Fig. 10 Digital Audio Connection

## 4. Setting up the Display Mode.

This HD-STB support all High Definition/ Standard Definition Video resolution of Australian Standard, you can select correct one for your HDTV/TV's reception ability.

For setting up the correct display resolution, adjustment two switches on the rear of the HD-STB.

Follow the Display Mode table.

DISPLAY MODE

	SD	HD 1	HD 2
M1	TV, S-VIDEO	1080i	1080i (1250)
M2	SD YPbPr	720p	1152i
M3	SD RGsB	576p	576p/1152i/1080i (1250)

For example, if you have HDTV, connect with YPbPr, and you want 1080i resolution, then DISPLAY Switch set to "HD1" and MODE Switch set to "M1"

If you setting up one mode and your HDTV cannot display correct picture, then your HDTV does not support that HD Video resolution. For example, if you select HD1 and M2 (720p mode) and your HDTV cannot display correct picture, then your HDTV does not support 720p resolution video mode.

At that time, simply try to other video mode. (1080i or 576p).

This HD-STB's HD1 is Native Mode display and HD2 is CRT Display setting. Usually, HDTV supported the Native Mode and HD Monitor supported CRT Display.

When you select HD1 or HD2 position, this HD-STB supported HD YPbPr and HD VGA simultaneously.

The HD2, M3 position is setting up Auto CRT Mode.  
Auto CRT Mode is deliver best picture without scan converting.  
If your HDTV support Auto CRT Mode, please feel free to try it.

Auto CRT Mode

Video Source	Output Display
576i	576p
576p	576p
720p	1152i
1080i	1080i(1250)

# Getting Started

## Step 1. Check up the contents in the Carton box.

After open the gift box, you should check up and find the following items.

- Digital HD-STB
- Universal Remote Control
- User's Guide
- Batteries (2 AAA/R03)
- SD A/V Cable (Yellow/White/Red) & HD Video Cable (Green/Blue/Red)
- RF Cable

If you find missing or broken part, then ask to supplier or contact to service center.

## Step 2. Connect ANT Cable.

Connect external ANT cable to ANT IN.

Connect another ANT cable between LOOP OUT of HD-STB and ANT IN of TV for analog reception.

## Step 3. Connecting the Video and Video Mode Setting.

Prepare HD-STB and HDTV you want to connect.

There are several methods to connection video. You should find correct connection method for your HDTV. Please refer Video Connection Diagram.

For the Video Mode Setting, you should check up the Display switch and Mode switch as follow.

### DISPLAY MODE

	SD	HD 1	HD 2
M1	TV, S-VIDEO	1080i	1080i (1250)
M2	SD YPbPr	720p	1152i
M3	SD RGsB	576p	576p/1152i/1080i (1250)

## Step 4. Connecting the Audio.

Prepare HDTV or Audio equipment you want to connect.

There are four different connection methods for Audio connection.

For general TV analog audio connection, it has AUDIO 1 and AUDIO 2.

It is quite same thing so you can select anything you want.

For digital audio connection, you should prepare Optical Audio cable for optical audio connection for Home Theater System.

If your Home Theater Equipment system has coaxial digital input, you can use well-shielded RCA cable for coaxial audio connection.

## Step 5. Connecting the Power.

Plug the Power Cord to wall AC outlet. The power source is AC 100-250V~/ 50/60Hz.

This unit is designed for continuous operation.

Switching it off does not disconnect it from the AC outlet. To disconnect this HD-STB from AC outlet, you have to unplug the HD-STB.

## **Step 6. Install Remote Control battery and TV Control Section Code Setting.**

Install Remote Control battery. The battery has polarity so when insert the batteries, make sure the "+" and "-" terminals are oriented correctly.

Setting up the TV Control Section Code. After finished the TV Control Section Code setting, the universal key of the HD-STB can control for your TV.

For TV Control Section Code setting, follow the following process.

1. Press and Hold TV POWER button.
2. Enter three digits TV Control Section Code.
3. Release the TV POWER button.

You can find the 3 digits code for your TV at the end of this User's Guide. Please refer to the TV Control Section code setting.

## **Step 7. Check up the On Screen Display.**

For verify correct setting of Display Mode, you should check up the OSD from HDTV's display screen.

Turn on the HD-STB and HDTV.

Press Menu button on the remote control, you should check up the OSD for verify A/V connection. If you cannot find any OSD in your TV display, please check up again the Display Mode switch position and A/V connection.

## **Step 8. Automatic Channel Search and Channel Change.**

Please processing the Automatic Channel Search and find possible channels. Please make sure, you should wait until fully searched.

You can change channel using CH▲ or CH▼ button in your remote control. Or you can direct select the channel using channel number.

Please make sure, the channel change operation is based on CH LIST in the internal memory. If you edit, delete and move the memorized channel, you cannot access the channel using CH▲ or CH▼ button or direct number enter. At that time, please perform the Automatic CH Tuning or Manual CH Search for re-Scan the channel.

If you setting up the favorite Channel using Program Preference and Favorite CH in the menu system, you can also change the channel using PR ►, PR ◀ button for Favorite Channel selection.

# INFO button and EPG Information Display

This HD-STB can display EPG information using INFO buttons. Press INFO button while watching TV you will get NOW and NEXT program information. By pressing INFO button again, you will get the more detailed information of NOW. Press INFO button third time, you will get the more detailed information of NEXT. Press EXIT button for quit the EPG Information display.

You can also move NOW and NEXT using PR ◀/▶ button.  
For the detailed information display, you can scroll Up/ Down using CH ▲/▼ button.

## 1. EPG Information Display

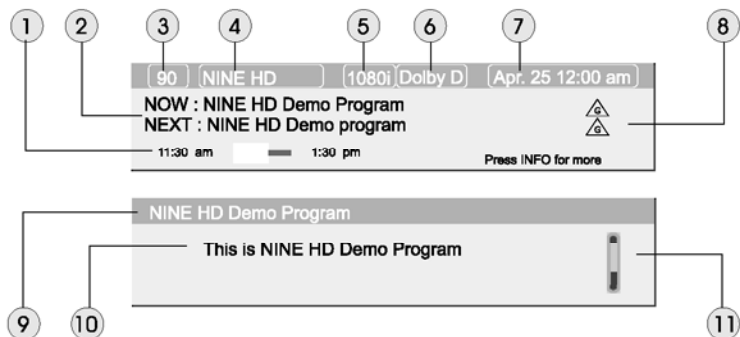

### 1. Program Schedule

It shows Start Time, Stop Time and Duration Information.

### 2. NOW and NEXT Information

It shows NOW and NEXT Program Name

### 3. Current CH Number

It is display the Current CH Number

### 4. Current CH Name

It shows Current CH Name

### 5. Source Video Resolution

It is display the current program's video resolution information

### 6. Audio Information

It is display the current program's audio information

### 7. Date and Time

It display current date and time information from broadcaster.  
Please make sure, this HD-STB cannot generate the date and time information.

### 8. Rating Information

It is rating information of NOW and NEXT program.

### 9. Program Name

It shows the Program Name of EPG information

### 10. Information contents

It displayed the current program's event title information contents

### 11. Scroll Bar

If this scroll bar display, the contents has followed more.  
Please use CH ▲ / ▼ button for access more contents.

## 2. Channel Information Display

Each time you change channels, the Channel Information will display right upper side automatically.

It will display 5 seconds for your reference.

You can see the current channel number, name, video source resolution, digital audio information and rating information.

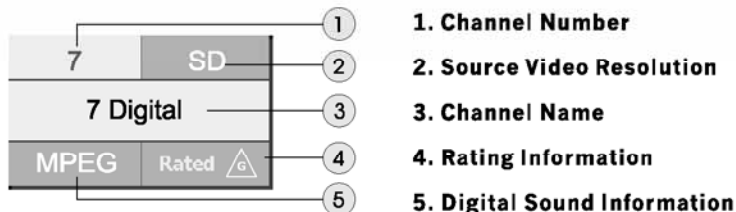

## 3. CH LIST Display

If you press CH LIST button on the remote control, you can see the CH LIST display for your reference. In the CH LIST, you can select available digital channel with CH ▲/▼, PR ◀/▶ button.

If you press FAV button on the remote control, the CH LIST to change to Fav1 CH LIST as favorite channel list which is set up in the Program Preference menu.

Each time press FAV button, it will change All → Fav1 → Fav2 → Fav3 → All

At the CH LIST display, if you can press QUICK CH button with CH selection bar, then you can assign that channel to QUICK CH.

At any time, if you can press QUICK CH, then the HD-STB will quick change the channel you assigned QUICK CH.

If you want to change QUICK CH, then just re-assign the QUICK CH at CH LIST display. Then it will re-assign the QUICK CH.

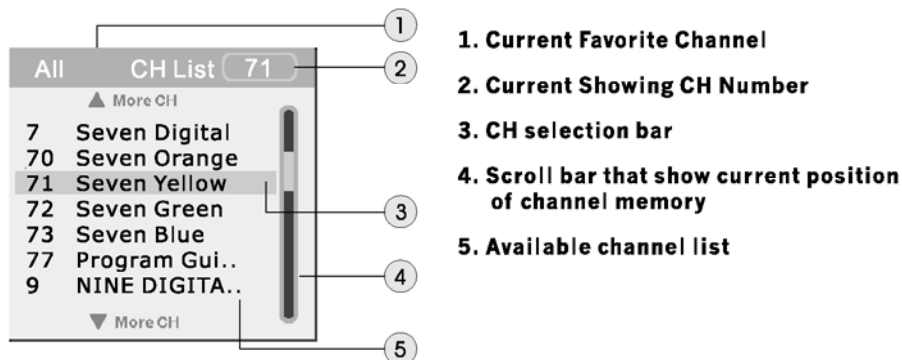

# Using the MENU System

From here you can adjust whole setting and function of HD-STB.

If you press the MENU button, the menu screen will display.

You can move up and down using CH ▲(UP) / ▼(DOWN) button, move left and right using PR ◀(LEFT) / PR ▶(RIGHT) button in the menu system.

To select the items, press ENTER. To quit the menu system, press EXIT.

Also, you can use RIGHT button for enter and LEFT button for go back to one step back.

## 1. Audio/Video Setting

From here you can adjust Audio/Video settings concerning your TV.

### TV Display

Select best fitting mode for your TV screen.

Also you can set up this function using WIDE button on the remote control.

This function is available only TV, S-Video, SD Video Output when the 16:9 source is coming from Broadcaster.

- 1) Press MENU button to display the menu.  
Press ENTER or DOWN to select the Audio/Video Setting menu.
- 2) Press ENTER or RIGHT to select the TV Display menu.
- 3) Press UP or DOWN to desired TV Display mode.  
You can select 4:3 PS, 4:3 LB or 16:9 mode.
- 4) Press ENTER or RIGHT to complete TV Display setting.

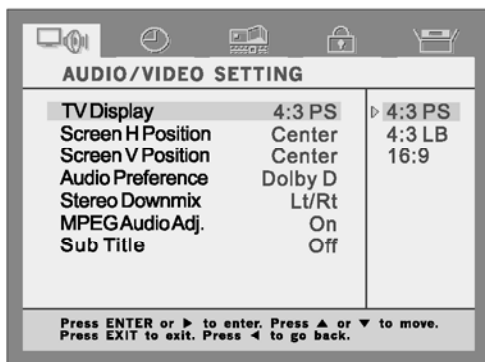

Select 4:3 PS when you want full screen on 4:3 display.

Select 4:3 LB when you want pre-scaled full original wide screen on 4:3 display.

Select 16:9 when you want wide screen on wide screen TV.



**Original 16:9 Source from Broadcaster**



**4:3 PS**  
**(Pan & Scan)**



**4:3 LB**  
**(Letter Box)**



**16:9**



## Screen H Position

Select best fitting Horizontal position for your TV screen. The whole picture will moved left or right. This function may not work on all TV's/displays.

## Screen V Position

Select best fitting Vertical position for your TV screen. The whole picture will moved up or down. This function may not work on all TV's/displays.

- 1) Press MENU button to display the menu.  
Press ENTER or DOWN to select the Audio/Video Setting menu.
- 2) Press ENTER or RIGHT to select the Screen H Position/ Screen V Position Menu.
- 3) Press UP or DOWN to desired position.
- 4) Press ENTER or RIGHT to complete position adjustment.

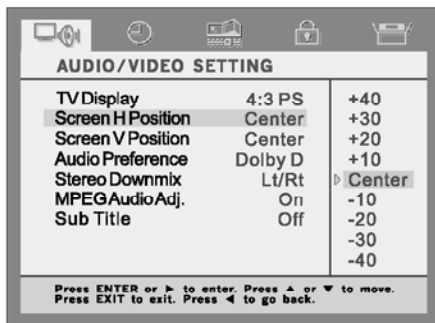

## Audio Preference

You can select desired audio signal from broadcaster.

If you select Dolby D (Dolby Digital) and broadcaster send Dolby Digital and MPEG audio at the same time, then your HD-STB will check up the Dolby Digital audio first and decode Dolby Digital audio.

If you select Dolby D (Dolby Digital) and broadcaster send MPEG audio only, then your HD-STB will check up the Dolby Digital audio first and next select MPEG audio automatically.

- 1) Press MENU button to display the menu.  
Press ENTER or DOWN to select the Audio/Video Setting menu.
- 2) Press ENTER or RIGHT to select the Audio Preference menu.
- 3) Press UP or DOWN to desired audio mode.
- 4) Press ENTER or RIGHT to complete Audio Preference select.

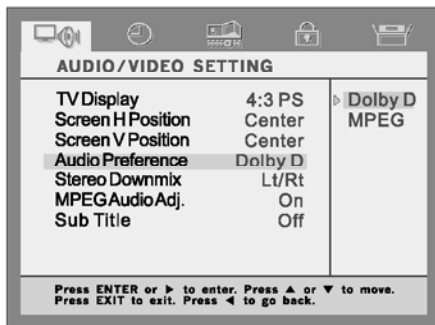

## Audio Downmix

For the stereo analog audio output, you can select Lt/Rt or Lo/Ro output mode.

For the analog stereo connection, set the Lt/Rt for correct audio information.

For the digital audio connection, set the Lo/Ro for full 5.1 channel support.

- 1) Press MENU button to display the menu.  
Press ENTER or DOWN to select the Audio/Video Setting menu.
- 2) Press ENTER or RIGHT to select the Audio Downmix menu.
- 3) Press UP or DOWN to desired audio downmix mode.
- 4) Press ENTER or RIGHT to complete audio downmix mode select.

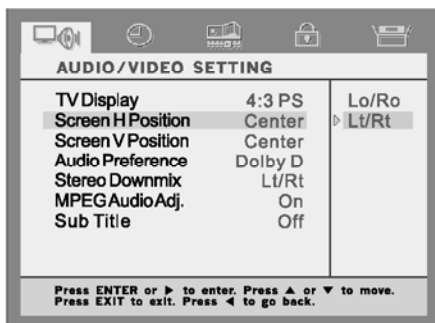

## MPEG Audio Adj.

If broadcaster simultaneous broadcast MPEG Audio and Dolby Digital Audio, generally the MPEG Audio Level is louder than Dolby Digital Audio.

When user set MPEG Audio Adj. On then the HD-STB will automatic decrease the MPEG Audio Level and make a similar Audio Level with Dolby Digital.

When user set MPEG Audio Adj. Off then the HD-STB will follow by original Audio Level from broadcaster.

For the analog audio connection, set to On for making similar audio level.

For the digital audio connection, set to Off for making similar audio level.

## Sub Title

In the Digital Broadcasting, the broadcaster broadcast Sub Title information with Audio and Video. You can see the Sub Title information using set up the Sub Title ON. In generally, Sub Title also called simple teletext or caption.

Also you can set up this function using S.TITLE button on the remote control.

If Sub Title is On, the Sub Title information will display followed by picture.

This HD-STB is not generated Sub Title, it is decode Sub Title information from Aerial signal. If Sub Title is On but do not display the Sub Title, check Aerial signal or consult your local broadcaster.

## 2. Time Setting

From here you can adjust time, timer and time related setting. For using timer related function, you should setting up the clock.

### Clock Setting

From here you can setup the current clock.  
If you set the Clock Setting to Off, the timer related function will disable and current time information will not display.

If you setup to Auto, this HD-STB will receive clock information from Aerial signal. The timer related function will work with Aerial signal clock information. Even if clock is incorrect, it came from broadcaster not this HD-STB. For the complete Auto clock setting, you should watch the TV program and wait couple of minutes to finish the Auto clock setting.

If you setup to Manual, you should enter the current clock and this HD-STB will setup the internal clock. The timer information will work with internal clock information. This HD-STB does not support battery back up for AC power failure.

- 1) Press MENU button to display the menu.  
Press LEFT or RIGHT to select TIME SETTING menu  
ENTER or RIGHT to select the Time Setting menu.
- 2) Press ENTER or DOWN to select the Clock Setting menu.
- 3) Press UP or DOWN to select desired Clock Setting mode.  
You can select Off, Auto or Manual.
- For the Manual clock setting, you should input current time information.
- 4) Press ENTER or RIGHT to complete setting.

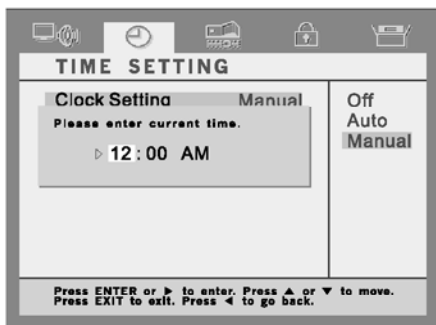
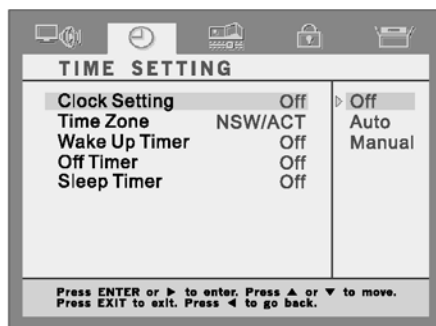

## Time Zone

From here you can setup the Time Zone.

You should enter the time zone information for correct time display when EPG information is display.

- 1) Press MENU button to display the menu.  
Press LEFT or RIGHT to select TIME SETTING menu  
ENTER or DOWN to select the TIME SETTING menu.
- 2) Press UP or DOWN to select the Time Zone menu.  
Press ENTER or RIGHT to select the Time Zone.
- 3) Press UP or DOWN to select desired Time Zone.
- 4) Press ENTER or RIGHT to complete TV Display setting.

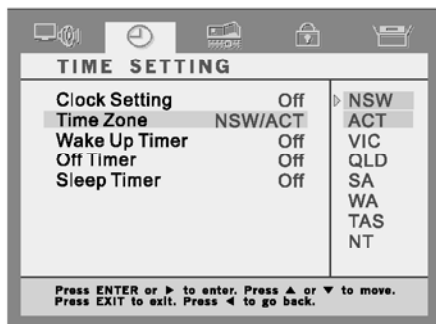

## Wake Up Timer

From here you can setup the Wake Up Timer for automatic turn on the HD-STB.

When the setting time is reached, the HD-STB will automatic turn on.

You can enter the desired wake up time and channel. For correct Wake Up Timer operation, you should set up the Clock Setting first.

- 1) Press MENU button to display the menu.  
Press LEFT or RIGHT to select TIME SETTING menu  
ENTER or DOWN to select the TIME SETTING menu.
- 2) Press UP or DOWN to select the Wake Up Timer menu.  
Press ENTER or RIGHT to select the Wake Up Timer.
- 3) Enter time, channel and activate setting.
- 4) After finished enter the informations, Press EXIT to completion of Wake Up Timer setting.

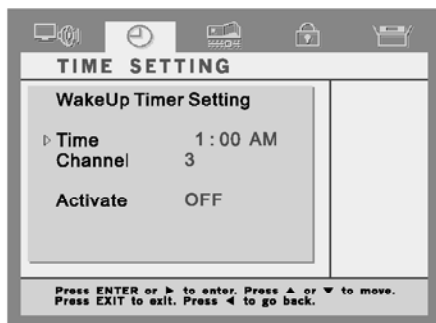

## Off Timer

From here you can setup the Off Timer for automatic turn off the HD-STB. When the setting time is reached, the HD-STB will automatic turn off. You should enter the desired off time.

For correct Off Timer operation, you should set up the Clock Setting first.

- 1) Press MENU button to display the menu.  
Press LEFT or RIGHT to select TIME SETTING menu  
Press ENTER or DOWN to select the TIME SETTING menu.
- 2) Press UP or DOWN to select the Off Timer menu.  
Press ENTER or RIGHT to select the Off Timer.
- 3) Enter desired off time and activate setting.
- 4) After finished enter the informations, Press EXIT to completion of Off Timer setting.

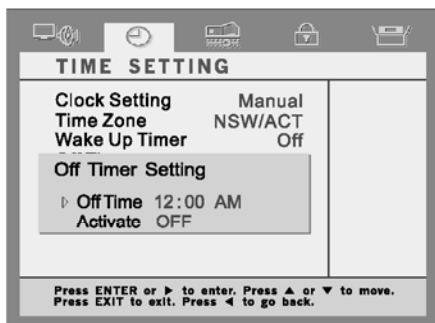

## Sleep Timer

From here you can setup the Sleep Timer. The HD-STB automatic turn off after existed period of time later. You can also setup the Sleep Timer using SLEEP button of remote control.

If you want disable Sleep Timer function, simply set up the Sleep Timer to "Off".

- 1) Press MENU button to display the menu.  
Press LEFT or RIGHT to select TIME SETTING menu  
Press ENTER or DOWN to select the TIME SETTING menu.
- 2) Press UP or DOWN to select the Sleep Timer menu.  
Press ENTER or RIGHT to select the Sleep Timer.
- 3) Press UP or DOWN to select desired sleep time.
- 4) Press EXIT to completion of Sleep Timer setting.

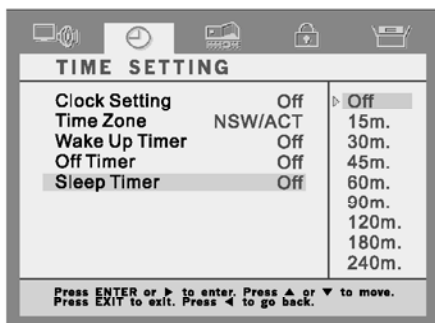

## 3. System Setup

From here you can setup the System Value of HD-STB. Also, you can restore the Factory Reset value. The PIN Code is not changed even factory value restored.

### Power Restore

This HD-STB has the Power Restore function. If you setup the Power Restore On and when AC Power is applied, the HD-STB will automatic turn on and display final memorized channel. It is useful for multiple display or exhibition for control the HD-STB. After setup the Power Restore On, then just turn on the AC Power for HD-STB On and Turn Off the AC Power for HD-STB Off.

The factory default value is Power Restore Off.

- 1) Press MENU button to display the menu.  
Press LEFT or RIGHT to select SYSTEM SETUP menu.  
ENTER or DOWN to select the SYSTEM SETUP menu.
- 2) Press UP or DOWN to select the Power Restore menu.  
Press ENTER or RIGHT to select the Power Restore.
- 3) Press UP or DOWN to select desired one.
- 4) Press EXIT to completion of Power Restore setting.

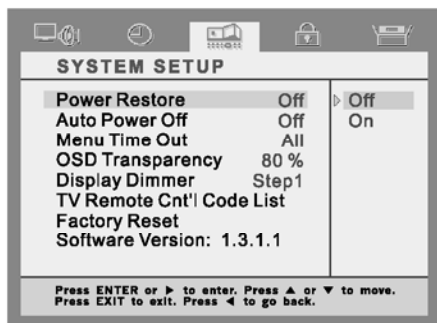

### Auto Power Off

This HD-STB has the Auto Power Off function. You can setup the Auto Power Off function on or off. After setup this function to on, if there is no aerial signal more than 90 minutes, then HD-STB will automatic turn off for prevent unwanted operation. If you setup to off, then this function is disable.

### Menu Time Out

You can adjust OSD (On Screen Display) display time. If you feel display time is too long or short, you can select time out period using Menu Time Out setup. If you set to All, then the menu will not disappear automatically. At that time, you can press EXIT to disappear the menu OSD.

### OSD Transparency

You can adjust OSD (On Screen Display) transparency. If you feel the menu display is too thick or thin, you can adjust the transparency of OSD using OSD Transparency setup.

## **Display Dimmer**

You can adjust Front seven segment display brightness.  
If you feel the Front Display is too brighter or darker, you can adjust the brightness of Display using Display Dimmer setup.

## **TV Remote Cnt'l Code List**

This HD-STB Remote Control can operate common functions on your TV.  
For the correct operation, you should setup the TV Remote control code.  
In this menu, you can find correct code for your TV. It might not work on some Model of TVs. ( Please refer to TV Remote Code Setting )

## **Factory Reset**

This HD-STB will change the factory default value after Factory Reset.  
Even perform the Factory Reset the PIN (Personal Identification Number) is not change. The HD-STB will ask to confirm to Factory Reset.

## **Software Version**

You can review the Software Version for future software upgrade.

## 4. Parental Guide

From here you can setup the PARENTAL GUIDE. You can block or unblock each program followed by parental guide information.

For the PARENTAL GUIDE setup, you should enter the PIN code.

The default PIN code is "0 0 0 0".

Once you enter the PIN code, it is validity until exit the menu system. Once the PIN code setup, it cannot be changeable without original PIN code.

### Block All Rating/Unblock All Rating

You can select block or unblock the whole ratings using Block All Rating/ Unblock All Rating. For the access of the Parental Guide setting, you should enter default PIN code "0 0 0 0"

- 1) Press MENU button to display the menu.  
Press LEFT or RIGHT to select PARENTAL GUIDE menu.  
ENTER or DOWN to enter the PARENTAL GUIDE menu.
- 2) Press UP or DOWN to select the Block All Rating/ Unblock All Rating menu.  
Press ENTER or RIGHT to enter the Block All Rating/ Unblock All Rating.
- 3) Press EXIT to completion of Block All Rating/ Unblock All Rating setting.

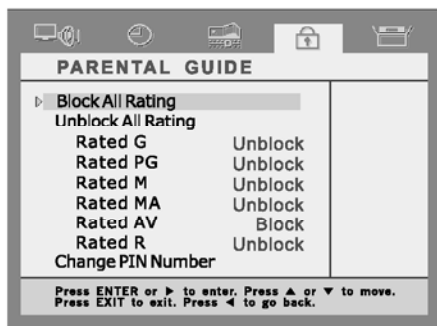



## Rating Setup

You can select block/ unblock the each rating one by one. If user select block the rating, that rating program will internal block and display violation of ratings message.

- 1) Press MENU button to display the menu.  
Press LEFT or RIGHT to select PARENTAL GUIDE menu  
ENTER or DOWN to enter the PARENTAL GUIDE menu.
- 2) Press UP or DOWN to select the desired rating menu.  
Press ENTER or RIGHT to enter the block/ unblock the desired rating.
- 3) Press EXIT to completion of Rating setup.

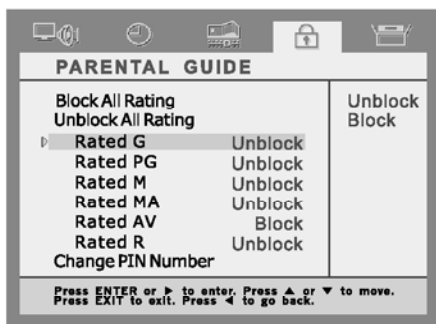

## Change PIN Number

From here, you can change the PIN code using Change PIN Number. Even if you want to change PIN number, you should input the old PIN number. The default PIN number is "0000" for the first access the PARENTAL GUIDE menu.

- 1) Press MENU button to display the menu.  
Press LEFT or RIGHT to select PARENTAL GUIDE menu  
ENTER or DOWN to enter the PARENTAL GUIDE menu.
- 2) Press UP or DOWN to select the Change PIN Number menu.  
Press ENTER or RIGHT to enter the Change PIN Number menu.
- 3) Please enter the 4 digits new PIN code using number button of Remote Control.
- 4) Press EXIT to completion of change PIN number setting.

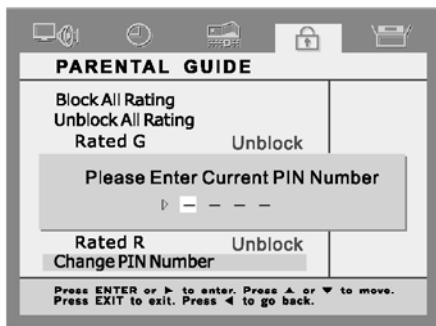

## 5. Channel Setup

From here you can do automatic and manual channel search, favorite channel setup, edit program and setting program preference.

### Automatic CH Tuning

From here the HD-STB will automatic search the whole frequency for available channels. It will take several minutes. Please wait to complete finished the automatic channel tuning. In this process, the HD-STB will display the search process for your review. If you quit the searching process, the HD-STB will not memorize found channels and it will discard.

- 1) Press MENU button to display the menu.  
Press LIFT or RIGHT to select CHANNEL SETUP menu  
ENTER or DOWN to select the CHANNEL SETUP menu.
- 2) Press ENTER or RIGHT to select the Automatic CH Tuning menu.
- 3) Press ENTER or RIGHT to start the Automatic CH Tuning.  
Please wait to complete finished this process.  
Usually, it will take several minutes.

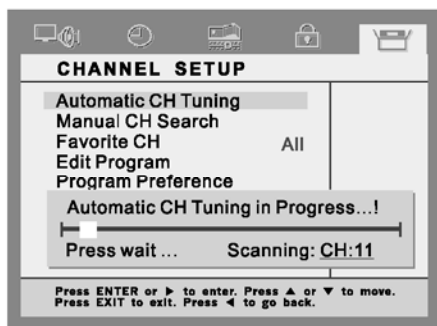

### Manual CH Search

From here you can manual find the available channel. For the manual channel search, you should enter the digital channel number of local broadcaster. When you perform the manual channel search, the HD-STB will try to find available digital program in the existed channel number. After finished manual channel search, the HD-STB will automatic memorized found channels.

- 1) Press MENU button to display the menu.  
Press LIFT or RIGHT to select CHANNEL SETUP menu  
ENTER or DOWN to select the CHANNEL SETUP menu.
- 2) Press ENTER or RIGHT to select the Manual CH Search menu.
- 3) Press ENTER or RIGHT to enter Manual CH Search menu.
- 4) Press UP or DOWN to select desired channel number.  
Press ENTER or RIGHT to start Manual CH Search process.

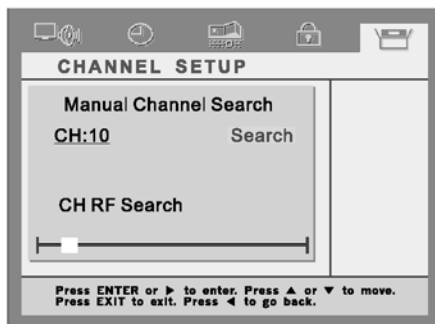

## Favorite CH

From here, you can select Favorite CH memory block. You can also select this function from your remote control FAV button. After favorite channel assigned in the Program Preference menu, you can select Favorite CH memory block for CH LIST display.

If you select All, the whole memorized channels will display when CH LIST display. So you can select desired channel from whole channel list. Also the PR ◀ / PR ► button will surfing the whole channels.

If you select Fav1, the Fav1 assigned channels in the Program Preference will display when CH LIST display. So you can select desired channel from Fav1 channel list. Also the PR ◀ / PR ► button will surfing the Fav1 channels.

Followed by above, you can assign Fav 2 and Fav3 memory block same method.

In the favorite channels movement, the CH ▲ / CH ▼ button always surfing the whole channels. The PR ◀ / PR ► button always surfing the favorite channels.

- 1) Press MENU button to display the menu.  
Press LEFT or RIGHT to select CHANNEL SETUP menu  
ENTER or DOWN to enter the CHANNEL SETUP menu.
- 2) Press UP or DOWN to select the Favorite CH menu.  
Press ENTER or RIGHT to enter the Favorite CH menu.
- 3) Please UP or DOWN to select the desired favorite memory block.
- 4) Press EXIT to completion of Favorite CH setting.

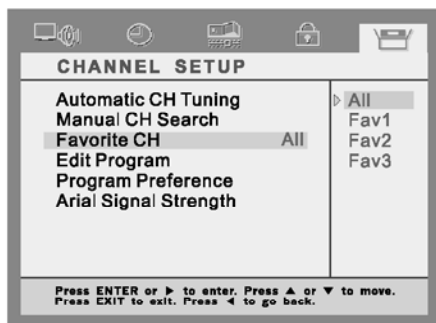

## Edit Program

From here, you can Edit, Move and Delete the memorized channels.

After performed the Automatic or Manual Channel Search, the whole channels are listed in the memory.

So, you can change the Channel name, sequence and delete from the memory.

After delete the channel, it can not appear in the CH LIST, at that time you should perform Automatic or Manual Channel Search for re-appear the channel in the CH LIST.

### Edit Program - Edit

In the digital broadcasting, the existed channel has there own names. But, if you want change the channel name, then you can change the channel name as you want.

- 1) Press MENU button to display the menu.  
Press LEFT or RIGHT to select CHANNEL SETUP menu  
ENTER or DOWN to enter the CHANNEL SETUP menu.
- 2) Press UP or DOWN to select the Edit Program menu.  
Press ENTER or RIGHT to enter the Edit Program menu.
- 3) Please UP or DOWN to select the program you want to change the name.  
Press ENTER or RIGHT to select the program.
- 4) Press UP or DOWN to select Edit and Press ENTER.  
Edit Program screen will display.
- 5) Press UP or DOWN to select alphabet for your desired channel name.  
Press ENTER for Completion of Edit or Press EXIT to Cancel.

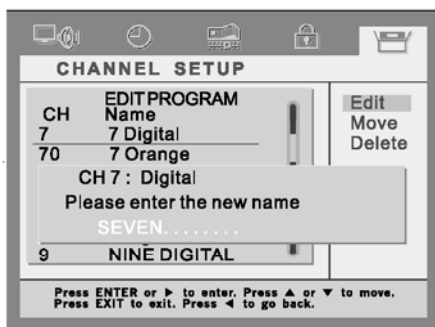
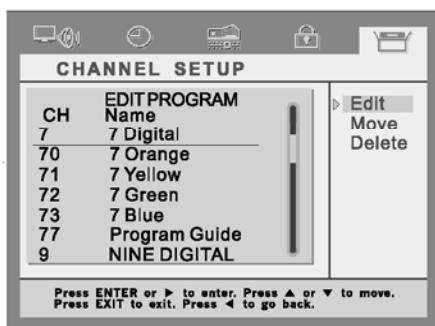

## Edit Program - Move

You can move the channel position in the memorized sequence. It is change the order of the memorized channels. And it is affected for CH ▲/▼, PR ◀/▶ operation using remote control.

- 1) Press MENU button to display the menu.  
Press LIFT or RIGHT to select CHANNEL SETUP menu  
ENTER or DOWN to enter the CHANNEL SETUP menu.
- 2) Press UP or DOWN to select the Edit Program menu.  
Press ENTER or RIGHT to enter the Edit Program menu.
- 3) Please UP or DOWN to select the program you want to move.  
Press ENTER or RIGHT to select the program.
- 4) Press UP or DOWN to select Move and Press ENTER.  
It will appear the marking for selected channel.
- 5) Press UP or DOWN to select actual position of destination.  
Press ENTER to move the channel.

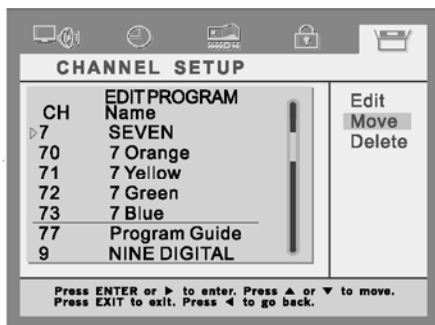
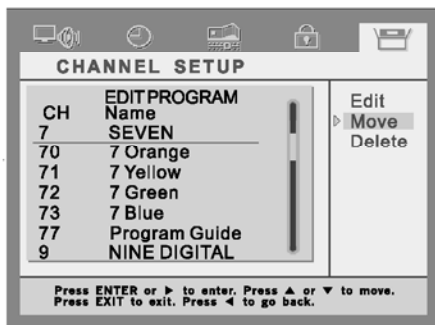

# Using the MENU System

## Edit Program - Delete

You can delete the unwanted channel in the internal memory. Once you delete the channel, you cannot access using CH ▲/▼, PR ◀/▶. For access deleted channels, you should perform Automatic CH Tuning or Manual CH Search operation to recover the memory.

- 1) Press MENU button to display the menu.  
Press LEFT or RIGHT to select CHANNEL SETUP menu.  
ENTER or DOWN to enter the CHANNEL SETUP menu.
- 2) Press UP or DOWN to select the Edit Program menu.  
Press ENTER or RIGHT to enter the Edit Program menu.
- 3) Please UP or DOWN to select the program you want to delete.  
Press ENTER or RIGHT to select the program.
- 4) Press UP or DOWN to select Delete and Press ENTER.  
It will appear the delete confirm message for selected channel.
- 5) Press ENTER to delete or Press EXIT to cancel.

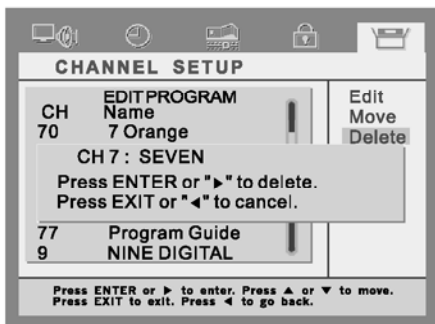

# Using the MENU System

## Program Preference

In the Program Preference menu, you can assign the Favorite Memory block for each channels. And blocking the selected channels.

The favorite memory block has three kinds, Fav1, Fav2 and Fav3.

Followed by FAV button or Favorite CH setting, you can access the Favorite Block CH LIST with LIST button.

For example, setting up the Fav1 for CH 7, 70 and 71 in the Program Preference menu. Also, select the Fav1 for Favorite CH menu, then the CH LIST will display for Fav1 favorite memory block like a Fav1 CH LIST. You can select the 7, 70 and 71 in the Fav1 CH LIST.

Also you can block the channels with setting the Block. For block the channels you should input the PIN code for access this menu. The default PIN code is "0 0 0 0"

- 1) Press MENU button to display the menu.  
Press LEFT or RIGHT to select CHANNEL SETUP menu.  
ENTER or DOWN to enter the CHANNEL SETUP menu.
- 2) Press UP or DOWN to select the Program Preference menu.  
Press ENTER or RIGHT to enter the Program Preference menu.
- 3) Please UP, DOWN, LEFT and RIGHT to select the program you want to mark.  
Press ENTER to mark the program.  
If you want un-mark the program, press ENTER again.
- 4) If you select the Block, then this HD-STB will ask PIN code. You should input the PIN code for activate the Block the channel.
- 5) After finished the setting, Press EXIT to finish the Program Preference menu.

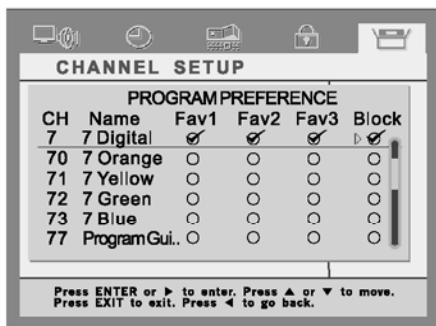
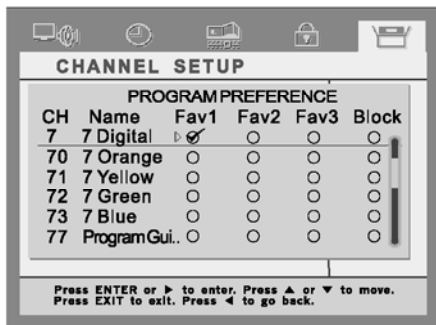

## Aerial Signal Strength

For the correct digital broadcasting reception, your signal level should be green level. The yellow level is partly received the digital broadcasting, but it is possible to unstable the picture quality.

The red level is unavailable digital broadcasting reception.

- 1) Press MENU button to display the menu.  
Press LEFT or RIGHT to select CHANNEL SETUP menu.  
ENTER or DOWN to enter the CHANNEL SETUP menu.
- 2) Press UP or DOWN to select the Aerial Signal Strength menu.  
Press ENTER or RIGHT to enter the Aerial Signal Strength menu.
- 3) Please UP or DOWN to change the channel you want to view the signal level.  
If you change the channel number, the video will temporarily stop to view.
- 4) After finished the review, Press EXIT to quit this menu.

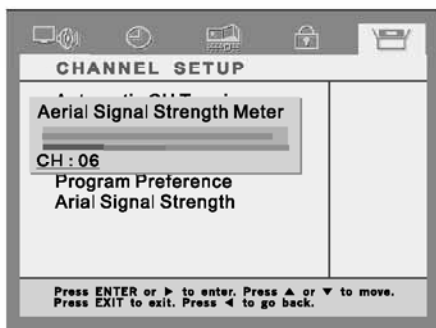



# Trouble Shooting

Your HD-STB is designed to give you trouble-free performance for many years. If you have a problem with your HD-STB, try the solutions listed below.

Problem	Possible causes	What to do
The display on the front panel does not light up.	Power cable is not connected.	Check up the Power cable which is plugged in to the AC wall mounted socket.
No Sound or Picture, but the front panel shows the time or "...:..."	The HD-STB is not powered ON	Press the power button on the front or remote controller to powered ON status.
Picture stop or squared picture	Signal too weak or No antenna connect.	Check the antenna or antenna connection. Simply check the analog reception of TV.
The Sound is OK, but the Picture is collapse	The HDTV does not support selected Video Resolution.	Simply change the DISPLAY switch and MODE switch to different video resolution.
The Sound is OK, but the Picture is Blank. The Picture is OK, but the Sound is Blank.	Audio or Video Connection is not good.	Check up the Audio/ Video cable or connection.
The remote control is not working	Battery exhausted. Remote control is incorrectly aimed. Blocked the HD-STB front panel	Change the batteries. Aim the remote control at HD-STB. Check that nothing blocks the front panel
The universal TV key is not working	Universal remote setting is initialized.	Resetting the Universal TV Code followed by manual.
You have forgotten your secret PIN number.		Contact Customer support, dial 1300 728 225 . They will help you set it up again.
The Parent Lock is not Setting up.		Please make sure the default code is " 0000 "

# Specifications

Section	Detailed section	Explanation
Terrestrial Input Signal	Input Frequency	VHF: 174MHz to 230MHz UHF: 520MHz to 820MHz
	Transmission System	DVB-T/OFDM
	Channel Assignment	Australian Channel Assignment
	Channel Bandwidth	7MHz
	Channel Offset	+/- 125KHz
	Input Signal Level	-90dBm ~ -20dBm
	Antenna Input	75Ω Female IEC-Connector (PAL Type)
	Loop Output	75Ω Male IEC-Connector (PAL Type)
	OFDM Spectrum Mode	2K and 8K Hierarchical
	Modulation Modes	QPSK, 16QAM, 64QAM
	Guard Interval Modes	1/32, 1/16, 1/8, 1/4 Active Symbol Duration
	FEC Modes	Rate 1/2, 2/3, 3/4, 5/6, 7/8
Video	Algorithm	MPEG-2 compatible MP@ML, MP@HL
	Decoding Format	All of Australia Digital TV Standard
	Display Aspect Ratio	16:9 or 4:3
	HD Video Output	All of Australia Digital TV Standard HD YPbPr/HD VGA Simultaneous Output Native Mode : 1080i, 720p, 576p CRT Display : (1250), 1152i, 576p
	SD Video Output	Common use of YPbPr/ RGB - 576i component output
	Composite Video Output	S-video(Y/C), Composite Video(CVBS)
Audio	Algorithm	MPEG-1 layers 1 and 2, MPEG-2 layers 2 Dolby Digital (AC-3)
	Frequency Response	20Hz~ 20 kHz, < ±2dB
	Sampling Frequency	32, 44.1 and 48 kHz
	Analog Audio Output	Stereo (RCA phone jack), 2.0Vrms, >10K ohm (2 Sets)
	Digital Audio Output	S/PDIF optical(TOS Link), S/PDIF coaxial(RCA)

Section	Detailed section	Explanation
Controller Features	Main CPU	32 bit RISC
	Menu System	Graphic User Interface
	Channel Memory	Max. 256 Channel
	Remote Controller	IR Remote Controller with Universal TV Key
Power	Power	AC 100 - 250V ~ ± 5%, 40W Max. 25W Nominal
	Operating Frequency	50/60Hz ±5%
	Standby Power Consumption	Less than 3 W
	Power Protection	Slow Blow Fuse (250V, 2A)
Environmental Condition	Operating Temperature	0 ~ 40 ℃
	Storage Temperature	-10 ~ +50 ℃
	Operating Humidity	5% ~ 90 % Non-condensed
	Storage Humidity	5% ~ 90 % Non-condensed
	Weight	Approx. 2.6Kg
	Dimension	340mm X 70mm X 270mm (WxHxD)

Note : Specifications are subject to change without notice

# TV Control Section Code

## Setting for remote control

You can use your HD-STB remote control for common function on your TV. ( might not work on some model of TVs).

After change the remote control battery, you should reset the TV Control Section code for your TV.

- 1) Look for correct code from TV Control Section Code List in user manual or in on-screen display.
- 2) Press and Hold TV POWER button on HD-STB remote control.
- 3) Enter three digits of TV Control Section Code.
- 4) Release TV POWER button.
- 5) Press TV POWER to confirm functionality on your TV.
- 6) If the code fails to operate the TV, please choose another code for the same brand and repeat 1) - 5)

Note: Please record the successful code for future reference.

TV Maker	Code
Admiral	141, 136, 072, 040,
Aiko	036, 048, 030, 026, 071, 067, 105, 040
AIWA	089, 093, 036, 092, 035, 039, 048, 078
Akai	020, 030, 048, 071, 063, 037, 044, 038, 078, 105, 026, 036, 067, 040, 143, 021, 080
Alba	063, 055, 036, 072, 100, 052, 030, 048, 031, 038, 034, 093, 068, 079
Amstrad	022, 036, 040, 088, 063, 030, 071, 064, 039, 048, 042
Anam	048, 036, 041
Audiosonic	048, 117, 100, 075, 040, 063, 106
Autovox	141, 076
Beko	100, 106, 048, 078
Best	075, 100
Bestar	048, 100, 035
Blaupunkt	105, 103, 143
Brother	040
Bruns	141
Bush	068, 063, 055, 036, 093, 062, 048, 052, 030, 035, 045, 040, 031, 034, 020, 038, 054
Cascade	036, 048
Casio	048
Cathay	048
Century	141
CGE	072, 100
Clarivox	072, 085
Concorde	036
Conic	134
Contec	036, 092, 089, 093
Continental Edison	117, 113, 110, 034

TV Maker	Code
Crown	036, 100, 106, 048, 079, 072, 020, 034, 096
Cybertron	063
Daewoo	036, 048, 035, 063, 047, 032
Denon	024
Digiline	048
Elekta	040, 062
Elite	063, 048
Emerson	022, 141, 021, 048, 056, 030, 085, 062
Ferguson	115, 114, 065, 160, 117, 069, 087
Fidelity	030, 040, 048
Fisher	104, 093, 098, 020, 100, 091, 025, 141, 092, 150, 067
Fujitsu	056, 076, 067, 066, 036
Galaxi	066, 048, 100, 072
GE	069, 117, 021, 062, 160, 111
GEC	027, 067, 048
General	117, 159
General Technic	036
GoldStar	048, 100, 134, 151, 036, 080, 021, 028
Goodmans	093, 067, 048, 036, 040, 151, 056, 035, 034, 050, 030, 047, 044, 111, 055, 026, 069, 134, 032, 160
Granada	048, 074, 161, 025, 067, 137, 020, 093, 016, 077, 160, 069
Grundig	103, 105, 034, 085, 048, 044
Hanimex	054
Hitachi	019, 093, 028, 027, 111, 010, 113, 110, 018, 134, 082, 014, 067, 013, 047, 048, 011, 024, 021, 044, 137
Imperial	048, 100, 072, 113

# TV Code Setting for remote control

TV Maker	Code
ITT Nokia	147, 020, 056, 016, 078, 049
JEC	026
JVC	096, 065, 093, 114, 030, 063, 078
Konka	063, 030, 048
Lemair	073
LG	048, 100, 134, 151, 036, 080, 021, 028
Loewe	046, 048, 141, 101, 100
Magnadyne	141, 066
Magnavox	093, 056, 048
Magnum	042
Manhattan	048, 068
Marantz	048
Masuda	063, 036, 030
Matsui	055, 022, 036, 052, 089, 090, 067, 093, 048, 044, 034, 031, 088, 054, 030, 071, 086, 079, 070, 026, 020, 025, 103, 105, 160
Mitsubishi	137, 046, 048, 136, 021, 088, 141, 090, 093, 077, 051
Morgan's	048
Motorola	136
NAD	095, 021
National	083
NEC	023, 093, 070, 036, 035, 048, 089
Nikko	021
Nokia	016, 020, 035, 078, 147
Nordmende	117, 113, 111, 110, 069, 103, 048, 160
Omega	040
Onwa	030, 037, 063, 071, 038
Orion	056, 055, 054, 022, 052, 089, 048, 036, 053, 050, 031, 065, 086, 044, 040, 039
Palsonic	040, 039, 048, 080
Panasonic	166, 057, 083, 099, 048
Philco	141, 072, 100, 048, 024
Philips	048, 044, 161, 105, 027, 141, 094, 111, 035
Phoenix	048, 141, 106, 100, 067
Pioneer	095, 048, 094, 100, 111, 117
Pionier	100, 106
Prima	134, 036, 040
Proton	021
Pye	048, 035, 044, 161, 141
RadioShack	048, 134, 021
RankArena	001, 002, 003, 004, 085
RCA	069, 087, 160, 136

TV Maker	Code
Saba	087, 141, 117, 111, 158, 113, 110, 160
Sampo	134
Samsung	029, 048, 044, 043, 036, 021, 143, 100, 040, 151, 134, 067, 020
Sansui	048, 030
Sanyo	165, 020, 092, 101, 093, 089, 100, 016, 067, 104, 025, 033, 036, 048, 091
Scott	021, 056
SEG	040, 036, 093, 066, 048, 068, 034
Sharp	136, 135, 092, 093, 054, 096
Siemens	105, 103, 092, 134, 048
Singer	141, 066, 074, 015, 036, 048
Skysonic	002, 048
Sony	138, 156, 153, 089, 093, 066
Supra	035, 036,
Tandy	063, 067, 136
Tatung	067, 048, 089, 139
Teac	048, 046, 070, 040, 036, 064, 039, 021
TEC	036, 159, 160, 075, 102
Technics	057
Teknika	056
Telefunken	117, 158, 159, 116, 160, 112, 115, 111, 113, 048, 106, 087
Tempest	036, 048
Thomson	087, 159, 160, 113, 110, 111, 048, 069, 117
Thorn	115, 065, 114, 047, 048, 104, 160, 046, 035, 026
Toshiba	026, 012, 017, 093, 085, 066
Toyoda	036
Vestel	048
Wega	093, 141, 048
Wharfedale	048, 045
Zanussi	076

Manufactured under license from Dolby Laboratories  
Dolby, Pro Logic and the double-D symbol are trademarks of  
Dolby Laboratories. Confidential unpublished works.  
Copyright 1992-1997 Dolby Laboratories. All rights reserved



**JVC**